

**Damper diode
fast, high-voltage**

BY329X-1700S

FEATURES

- Low forward volt drop
- Fast switching
- Soft recovery characteristic
- High thermal cycling performance
- Isolated mounting tab

SYMBOL

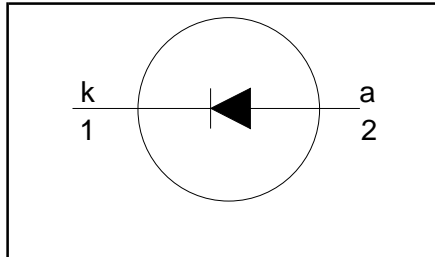

QUICK REFERENCE DATA

$V_R = 1700\text{ V}$
$V_F \leq 1.5\text{ V}$
$I_{F(\text{PEAK})} = 6\text{ A}$
$I_{\text{FSM}} \leq 60\text{ A}$
$t_{\text{tr}} \leq 170\text{ ns}$

GENERAL DESCRIPTION

Glass-passivated double diffused rectifier diode featuring low forward voltage drop, fast reverse recovery and soft recovery characteristic. The device is intended for use in TV receivers and PC monitors.

The BY329X series is supplied in the conventional leaded SOD113 package.

PINNING

PIN	DESCRIPTION
1	cathode
2	anode
tab	isolated

SOD113

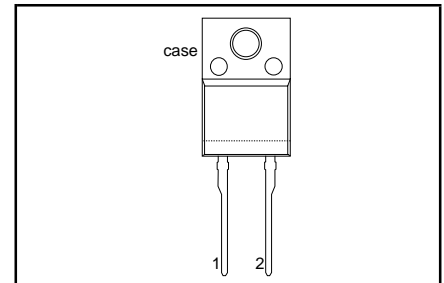

LIMITING VALUES

Limiting values in accordance with the Absolute Maximum System (IEC 134).

SYMBOL	PARAMETER	CONDITIONS	MIN.	MAX.	UNIT
V_{RSM}	Peak non repetitive reverse voltage		-	1700	V
V_{RRM}	Peak repetitive reverse voltage		-	1700	V
V_{RWM}	Crest working reverse voltage		-	1300	V
$I_{\text{F(peak)}}$	Peak working forward current	$f = 16\text{ kHz}$	-	6	A
		$f = 64\text{ kHz}$	-	6	A
I_{FRM}	Peak repetitive forward current	$t = 25\text{ }\mu\text{s}; \delta = 0.5; T_{\text{hs}} \leq 91\text{ }^\circ\text{C}$	-	14	A
$I_{\text{F(RMS)}}$	RMS forward current		-	10	A
I_{FSM}	Peak non-repetitive forward current	$t = 10\text{ ms}$ sinusoidal; $T_j = 150\text{ }^\circ\text{C}$ prior to surge; with reapplied $V_{\text{RWM(max)}}$	-	60	A
T_{stg}	Storage temperature		-40	150	$^\circ\text{C}$
T_j	Operating junction temperature		-	150	$^\circ\text{C}$

ISOLATION LIMITING VALUE & CHARACTERISTIC

$T_{\text{hs}} = 25\text{ }^\circ\text{C}$ unless otherwise specified

SYMBOL	PARAMETER	CONDITIONS	MIN.	TYP.	MAX.	UNIT
V_{isol}	R.M.S. isolation voltage from both terminals to external heatsink	$f = 50\text{-}60\text{ Hz}$; sinusoidal waveform; R.H. $\leq 65\%$; clean and dustfree	-		2500	V
C_{isol}	Capacitance from both terminals to external heatsink	$f = 1\text{ MHz}$	-	10	-	pF

Damper diode
fast, high-voltage

BY329X-1700S

THERMAL RESISTANCES

SYMBOL	PARAMETER	CONDITIONS	MIN.	TYP.	MAX.	UNIT
$R_{th\ j-hs}$	Thermal resistance junction to heatsink	with heatsink compound	-	-	4.8	K/W
$R_{th\ j-a}$	Thermal resistance junction to ambient	without heatsink compound in free air.	-	55	5.9	K/W

STATIC CHARACTERISTICS

$T_j = 25\text{ }^\circ\text{C}$ unless otherwise stated

SYMBOL	PARAMETER	CONDITIONS	MIN.	TYP.	MAX.	UNIT
V_F	Forward voltage	$I_F = 6.5\text{ A}$	-	1.35	1.65	V
I_R	Reverse current	$I_F = 6.5\text{ A}; T_j = 125\text{ }^\circ\text{C}$ $V_R = V_{RWMmax}$ $V_R = V_{RWMmax}; T_j = 125\text{ }^\circ\text{C}$	-	1.2	1.5	V μA mA

DYNAMIC CHARACTERISTICS

$T_j = 25\text{ }^\circ\text{C}$ unless otherwise stated

SYMBOL	PARAMETER	CONDITIONS	MIN.	TYP.	MAX.	UNIT
V_{fr}	Forward recovery voltage	$I_F = 6.5\text{ A}; di_F/dt = 50\text{ A}/\mu\text{s}$	-	30	40	V
t_{fr}	Forward recovery time	$I_F = 6.5\text{ A}; di_F/dt = 50\text{ A}/\mu\text{s}; V_F = 5\text{ V}$	-	300	320	ns
t_{rr}	Reverse recovery time	$I_F = 1\text{ A}; -di_F/dt = 50\text{ A}/\mu\text{s}; V_R \geq 30\text{ V}$	-	130	170	ns
Q_s	Reverse recovery charge	$I_F = 2\text{ A}; -di_F/dt = 20\text{ A}/\mu\text{s}; V_R \geq 30\text{ V}$	-	0.7	1.0	μC

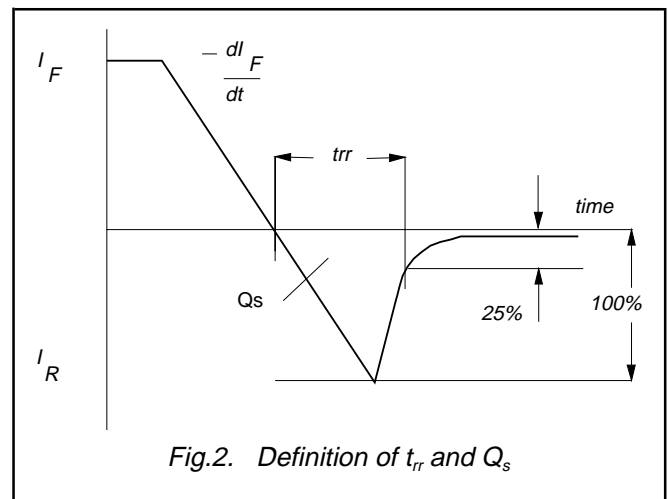
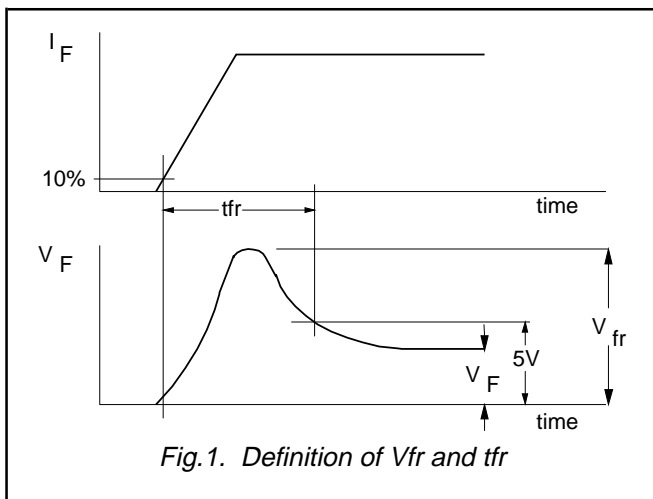

Damper diode
fast, high-voltage

BY329X-1700S

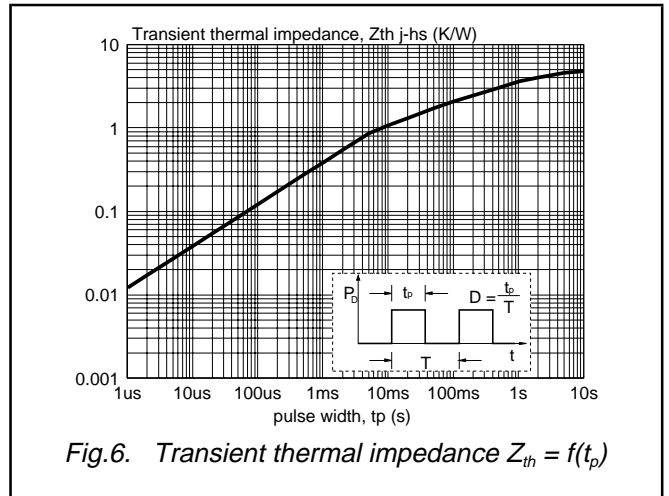
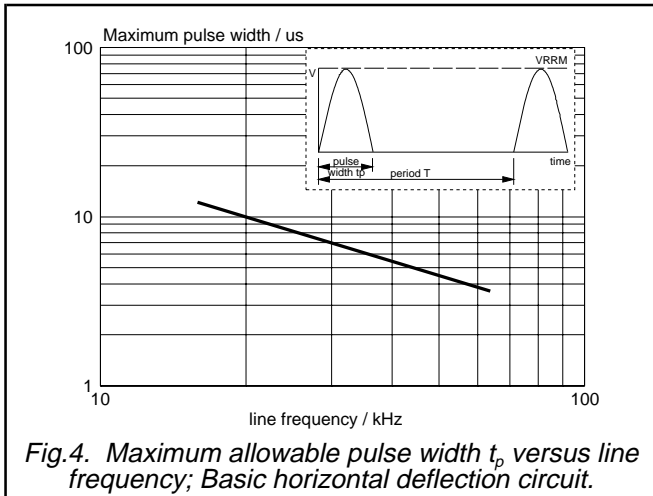
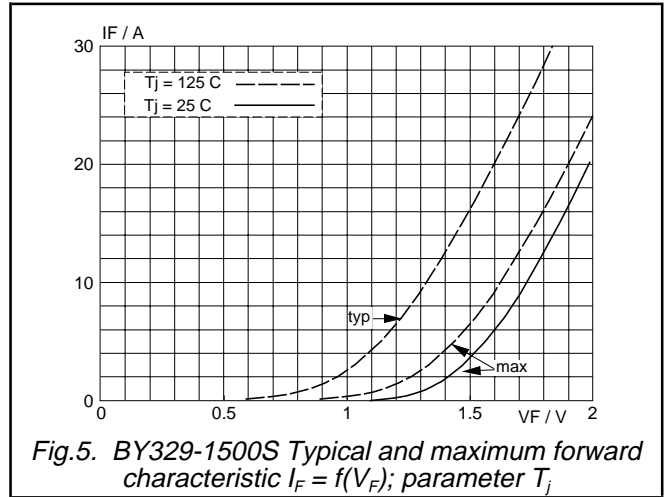
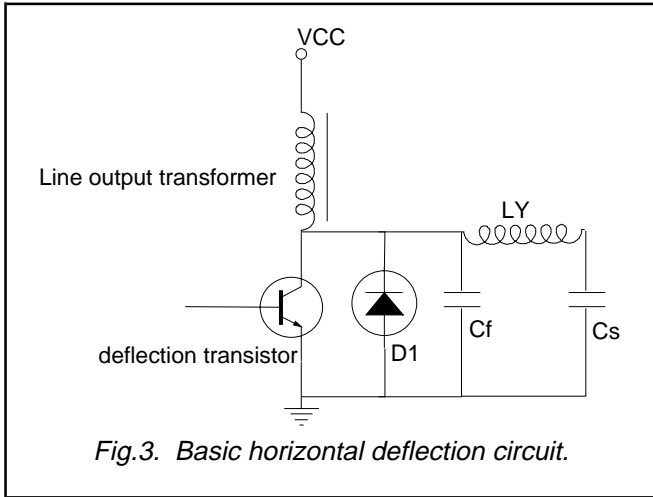

Damper diode
fast, high-voltage

BY329X-1700S

MECHANICAL DATA

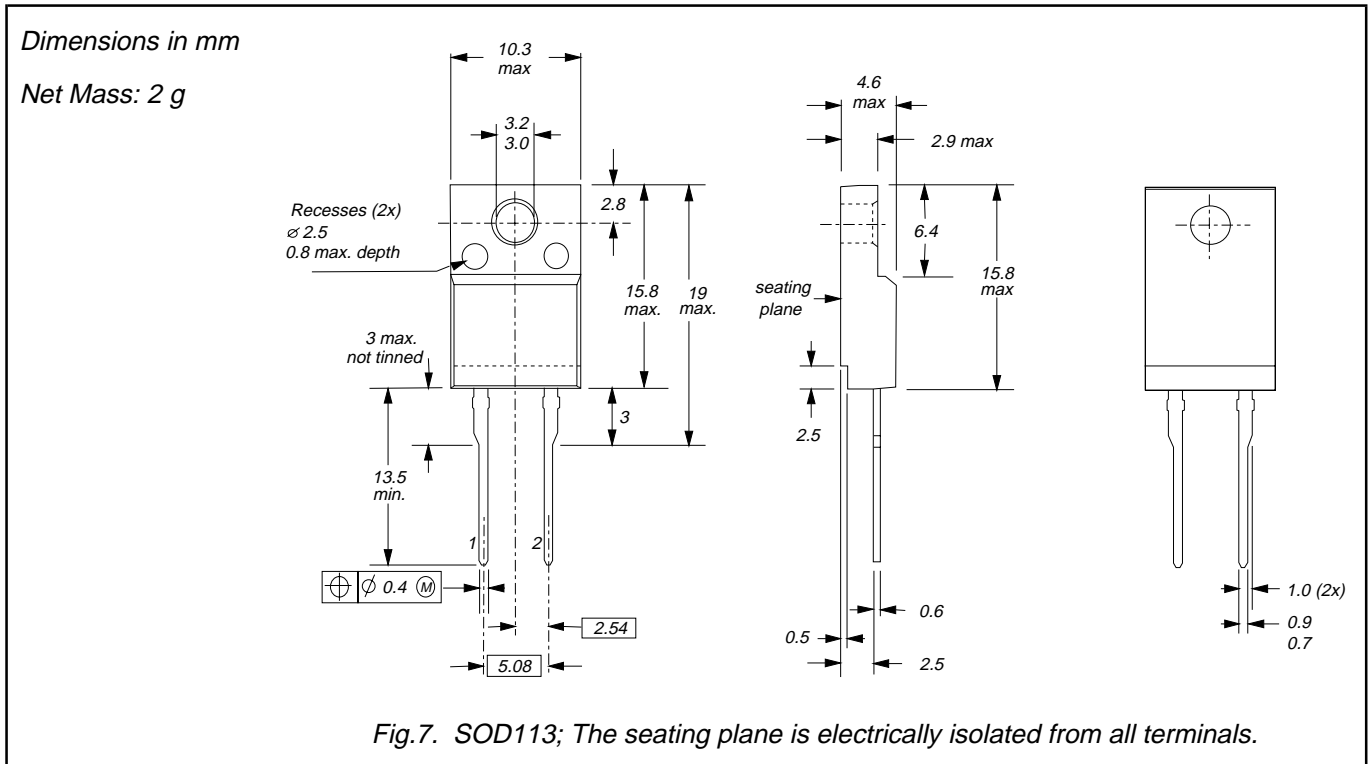

Notes

1. Refer to mounting instructions for F-pack envelopes.
2. Epoxy meets UL94 V0 at 1/8".